

9" X 9" REMOVABLE TYPE ALUMINUM WINDOW BARS INSTALLATION INSTRUCTIONS

Import Note :

- 9" X 9" Spacing Removable Type Installation is covered in this Instruction.
- Removable Bars Only Mount in Recess Position (Between Window Jamb/ Frame)
- The spacing between horizontal bars is 9".
- The spacing between two vertical bars is 9".
- The Height of Vertical Bars is 2" less than Opening Height to allow unlocking and Lift the Bars.
- We custom cut and make Window bars for your Order for Opening Size of Window.



9" X 9" REMOVABLE TYPE ALUMINUM WINDOW BARS INSTALLATION INSTRUCTIONS

9" X 9" Removable Mount Lay Out Example:

9" X 9" Removable Window Bars layout Example

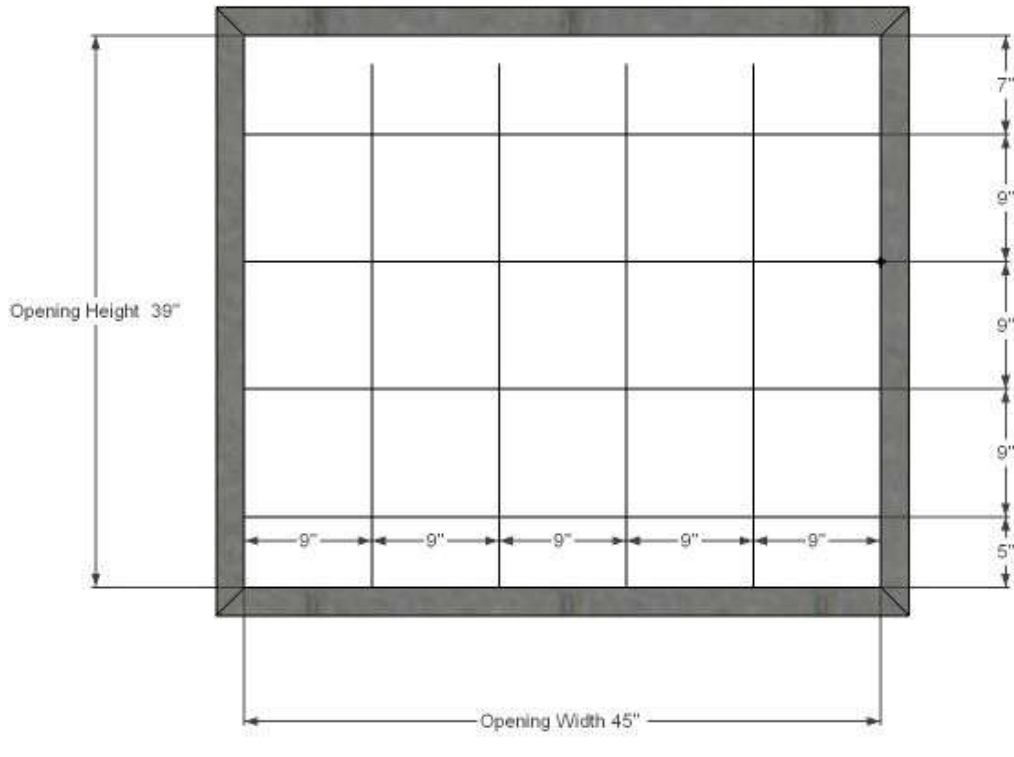

Procedure to calculate # of Horizontal Bars

Opening height is 39" *Divide opening height with 9*. Because standard space between two bars is 9" for 9" X 9" type Bars. (i.e.: $39/9 = 4.33$)

4 is whole number so there will be 4 horizontal bars.

Find the distance from the First Horizontal bar to the Bottom of Frame.

- Vertical bars are 2" less than the opening height for allowance of installation. So the vertical bars are at a height of 37".

- 4 horizontal bars will create a total of 5 spaces **between top and bottom of window frame** as shown above.

- 4 horizontal bars will create 3 spaces **between the Top and Bottom Horizontal Bars**. That will be a 9" standard space, therefore three spaces multiply by nine inches ($3 \times 9" = 27"$). *27" Space will occupy between 4 Horizontal Bars.* (So the remaining space is 37" (vertical bars height) - 27" = 10 Inches.)

Now that 10 Inches are left for 2 the remaining two notch spaces, space between the top horizontal bar and top frame of the window (1st Space) and space between the bottom bar and bottom window frame. (2nd Space) So Divide Available remaining Height by 2. (i.e. $10 / 2 = 5"$)

- There will be 5" space required from the bottom frame of window to first the Horizontal Bar. *Find out this measurement for your opening height and mark this measurement on your window frame.* Mark 5/16" Below of the first horizontal bars for Locking Bracket. Now, the distance between the top bar and top of the window frame will be 7". Why? The 5" space from above the number and 2" we have deducted an amount for the allowance of Removable bars to Operate for Removing. Makes a total of 7"

9" X 9" REMOVABLE TYPE ALUMINUM WINDOW BARS INSTALLATION INSTRUCTIONS
Important: This Lay out Example is for Guidance purpose only. Use your Opening Size to find out Space between bottom horizontal bar and bottom of window frame.

Layout Example 2

Aluminum window bar layout example for 9" x 9" spacing.
 Window is 36" high, vertical bars are cut at 34" high, leaving a 2" space at the top of the window. Take the length of the vertical bar subtract the distance inbetween the horizontal bars and divide the remainder by two, this gives you height to the center of first horizontal bar

The next horizontal bar would be 9" above the first horizontal bar.

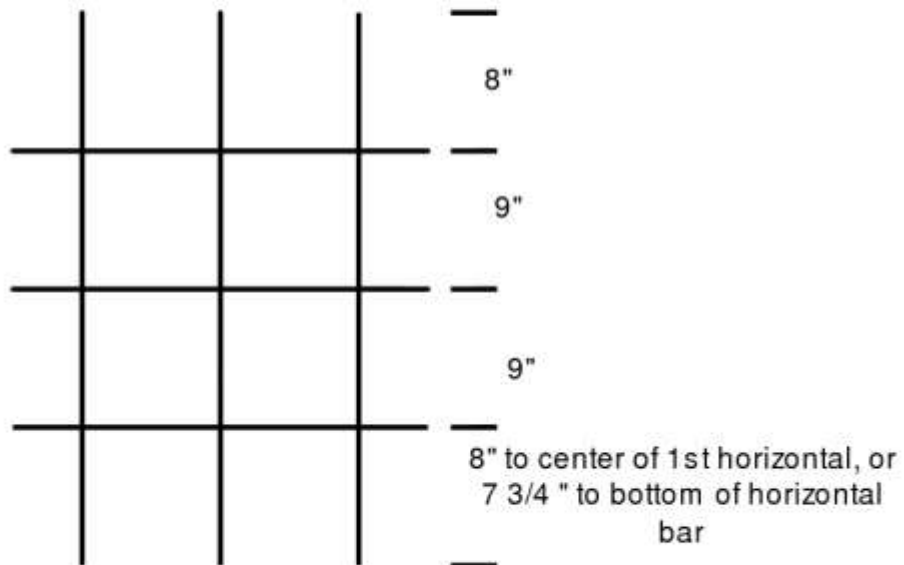

$$34" \text{ minus } 18" = 16"$$

$$16" \text{ divide by } 2 = 8"$$

9" X 9" REMOVABLE TYPE ALUMINUM WINDOW BARS INSTALLATION INSTRUCTIONS

WINDOW BARS COMMON PARTS

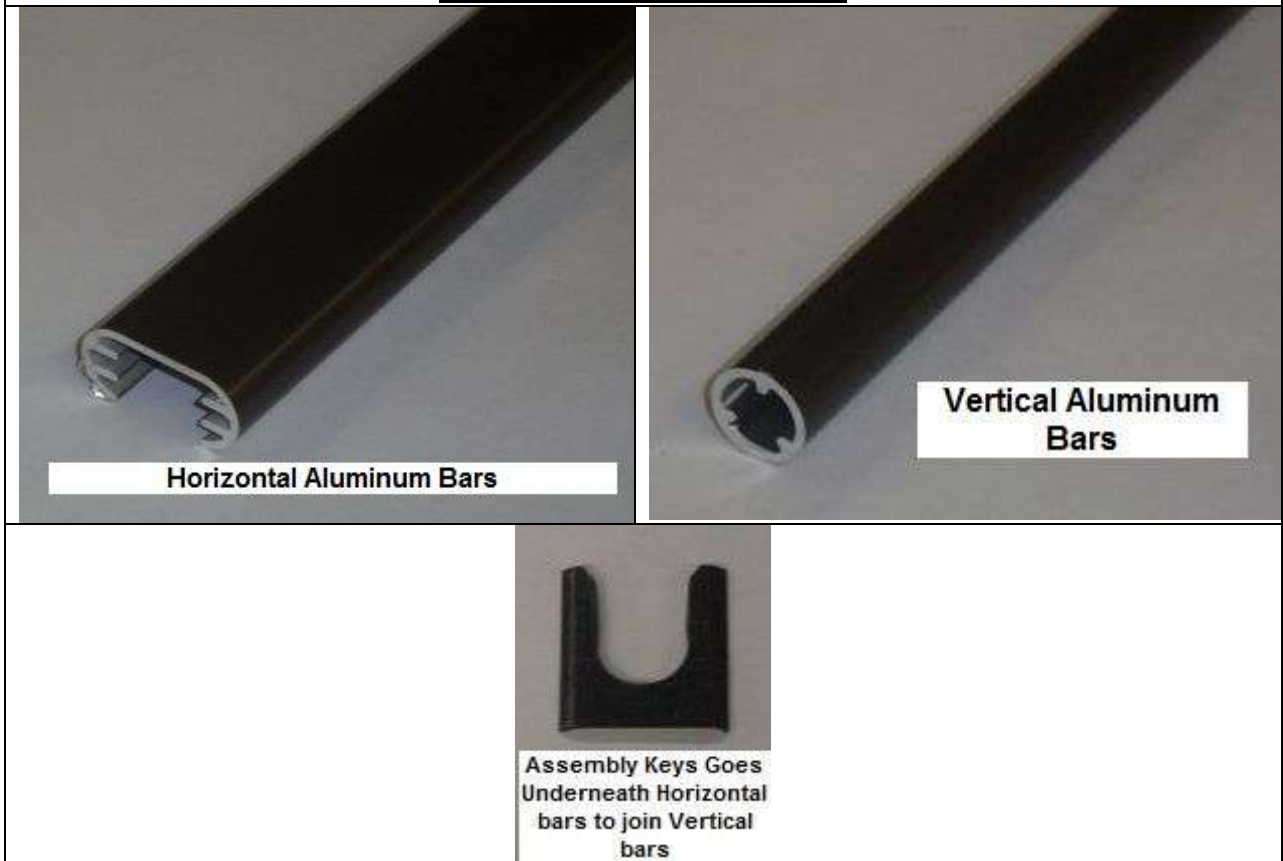

9" X 9" REMOVABLE TYPE ALUMINUM WINDOW BARS INSTALLATION INSTRUCTIONS

ADDITIONAL PARTS FOR REMOVABLE MOUNT

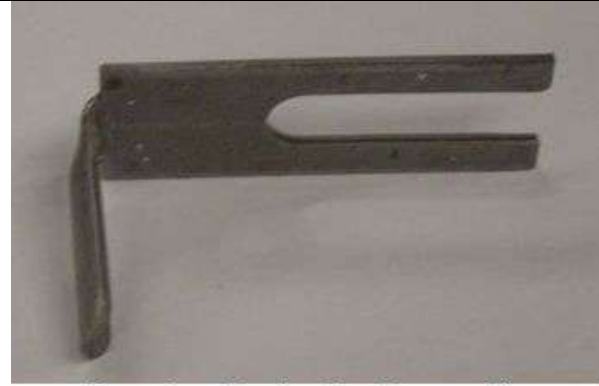

Mounting Bracket for Removable Bars (Except for Locking)



Mounting Channel for Removable Bars (Not for Lock)



Locking Bracket for Removable Bars

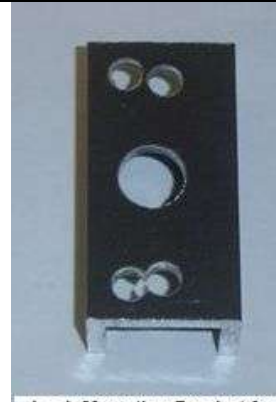

Lock Mounting Bracket for Removable Bars



Lock for Removable Bars



Lock Mounted on Mounting Channel for Removable Bars

9" X 9" REMOVABLE TYPE ALUMINUM WINDOW BARS INSTALLATION INSTRUCTIONS

ASSEMBLY- INSTALLATION GUIDE



Do a Window Bar Lay Out on paper. Take Guidance from the example shown above. Once you have lay out ready Transfer/ Mark measurement to Window Frame. Make Sure Bracket goes 5 /16" below the horizontal bars on to the frame. See lay Out Sheet example above. 9" from the top of first bracket to Top of next bracket .This is a very important step to install bars correctly. Mark on both sides same way so it is in level



After figuring out First horizontal bar distance from bottom of Frame to Center of First Horizontal bar , Mount U Channel Locking Bracket to Window Frame such a way it stays 5/16" below center of first Horizontal bars on both side.

Attach Both Side Locking Channel Brackets with Screws, Diagonally with Top Screws towards Glass Side only at bottom. See Picture Below



After first horizontal bars Bracket, Please note that Other U channel Bracket which do not have lock, need screws only on Glass Side. These bracket will go 9" after first horizontal bars bracket (Top to top measurement)



9" X 9" REMOVABLE TYPE ALUMINUM WINDOW BARS INSTALLATION INSTRUCTIONS

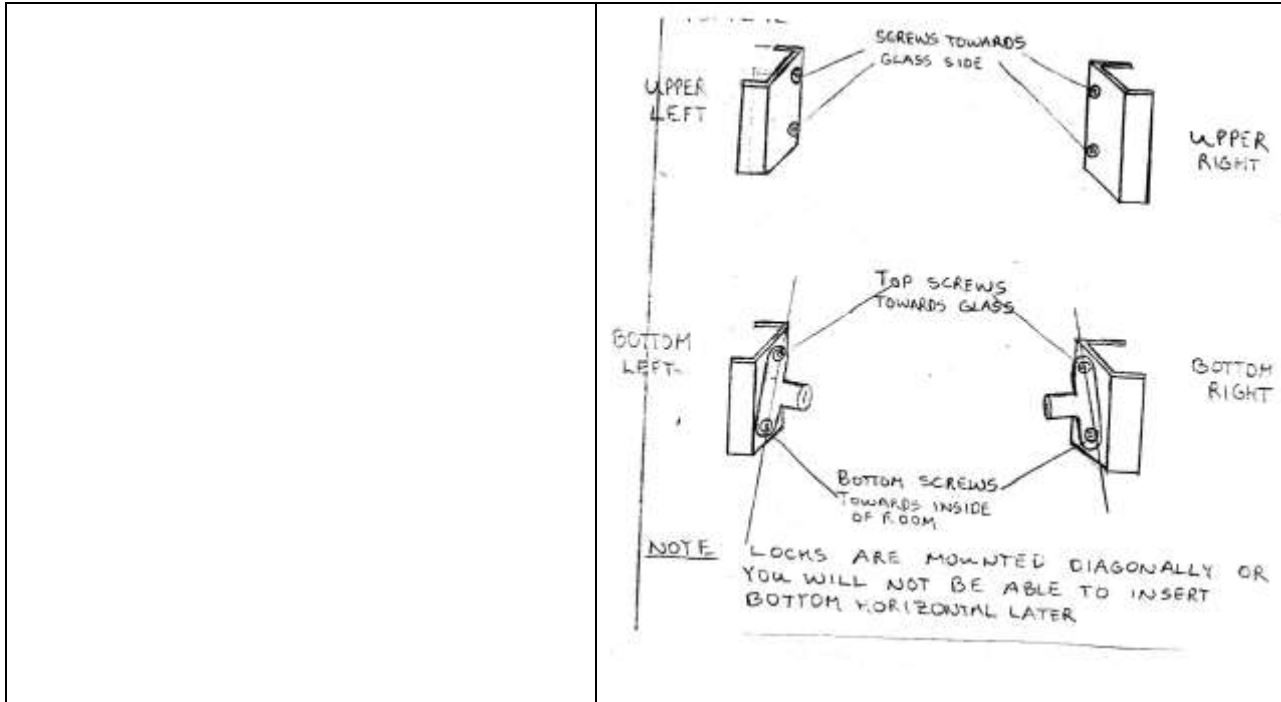

After, You have Installed all Brackets on Window frame, Insert Assembly Keys (Clips) underneath of Horizontal Bars near each hole.



Insert locking "L" Bracket to both End of first Horizontal bars and then Insert to U channel Bracket



9" X 9" REMOVABLE TYPE ALUMINUM WINDOW BARS INSTALLATION INSTRUCTIONS



Install First Horizontal Bars and Drop vertical bars into holes. Do not set assembly keys (Clips) yet. Do not tight fully at this point



Slide the rest of Horizontal bars into place , Every 9"



Set Assembly Keys, Making sure to have a 2" Space at Top for Removable Bars



9" X 9" REMOVABLE TYPE ALUMINUM WINDOW BARS INSTALLATION INSTRUCTIONS

Short Version Installation Instructions

CHANNEL MOUNT - REMOVABLE

First make certain you have the correct kit for the window you are to install.

Measure the window vertical height and subtract 12" x number of horizontals less 1. This will give a number larger than twelve. Divide by 2, subtract 5/16" and this will give you the top edge of bottom U channel. All U channels above this are in units of 12". (A 10" strip of any material makes a good spacing tool as channels are 2" long). Hold or clamp the U channel in place (Fig. 3-1 & 3-2) and using the supplied self drilling screws firmly mount the U channels to frame. (Mounting surface other than hollow aluminum may require different screws, not supplied). Place locking U channels (Fig. 3-2) if used, at correct height.

Next take horizontal bars and (Fig. 3-3) slide one assembly key adjacent to each vertical bar opening. (Make sure they are faced the right way). Slide one angle into each end. Place bent locking angles in same bar which will be positioned to match locking channels. Fork end of mounting angle may be slightly bent to make angle fit snugly.

Place lowest horizontal in place by dropping the angles into the channels. Place all verticals in lowest bar. There will be a 2" space at top to allow grid removal. Position each horizontal in turn over verticals and drop to next lowest position. Continue until all bars are in place. Check to make sure there is an assembly key at each vertical (they may slip out of place during handling).

Using the vice grip clamping tool, securely press locking keys all the way onto vertical bars. Use caution when setting keys so as not to disturb position of horizontal. When all keys are secure, push locks closed.

Installation is complete.

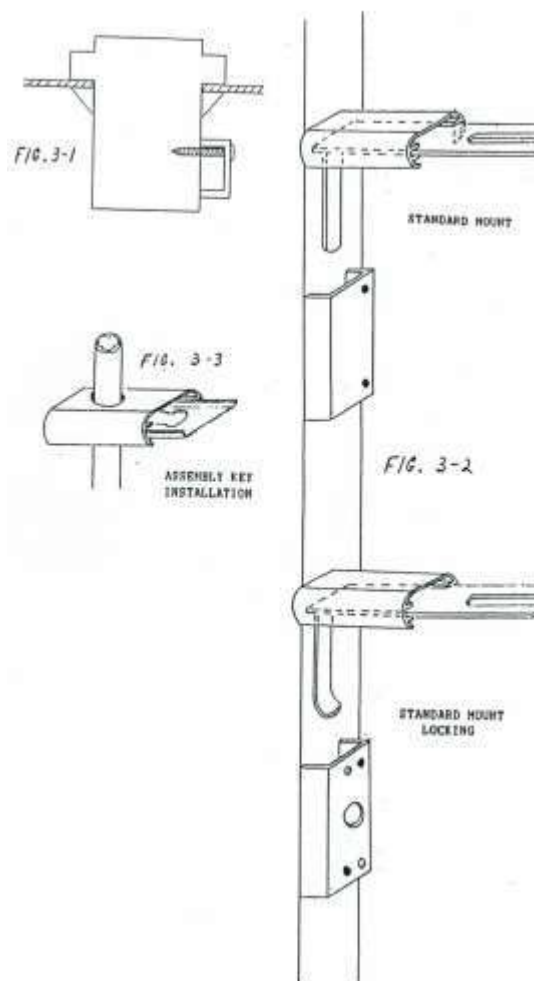

9" X 9" REMOVABLE TYPE ALUMINUM WINDOW BARS INSTALLATION INSTRUCTIONS

More Installation Pictures



Important: The Lay out Example and Installation Instructions is for Guidance purpose only. Use your Opening Size to find out Space between bottom horizontal bar and bottom of window frame with help from lay out Instructions.