

I-Beam Track

Curvable at job site
to a 12" minimum radius

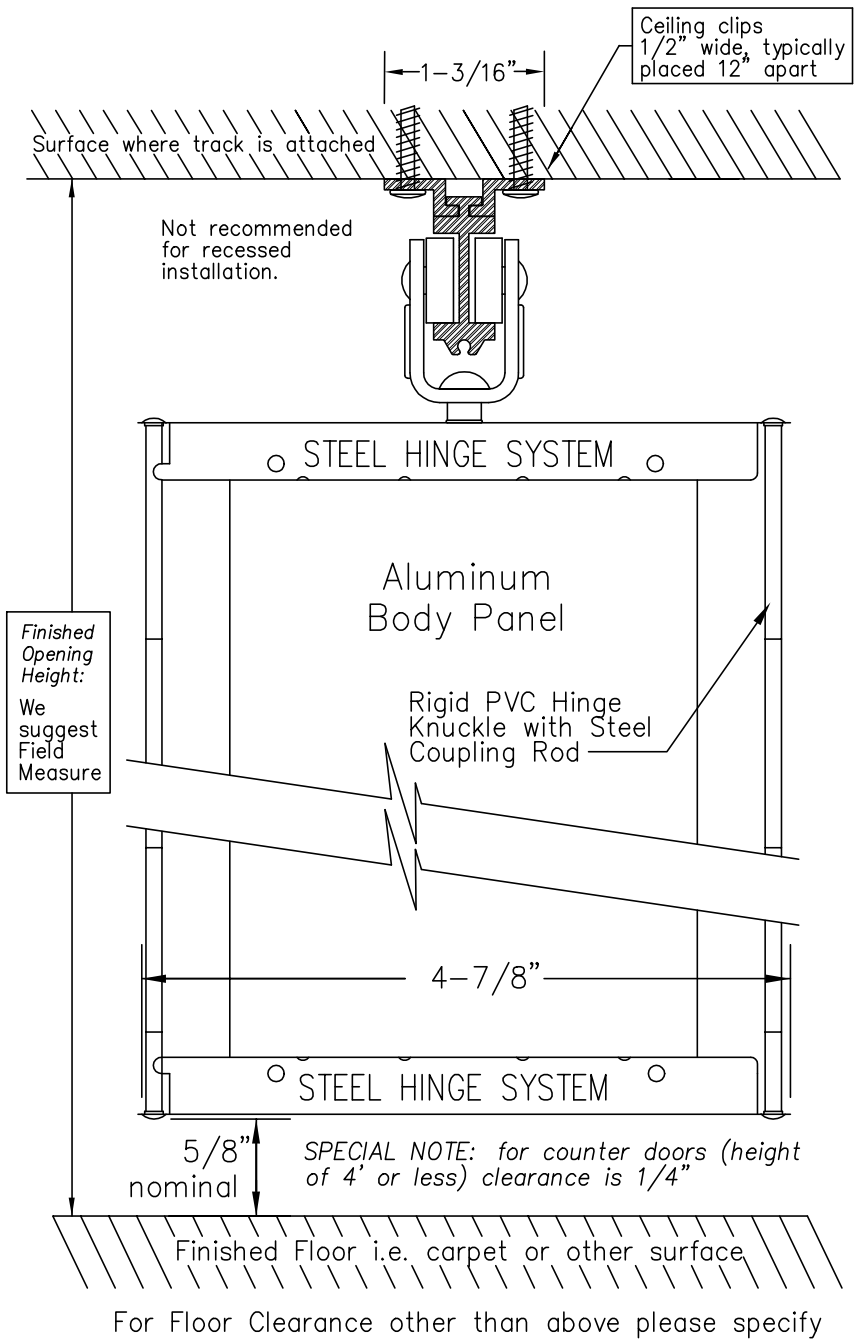

CAD IBM-740

○ I-BEAM — MODEL 740