

Intermediate Rolling Post

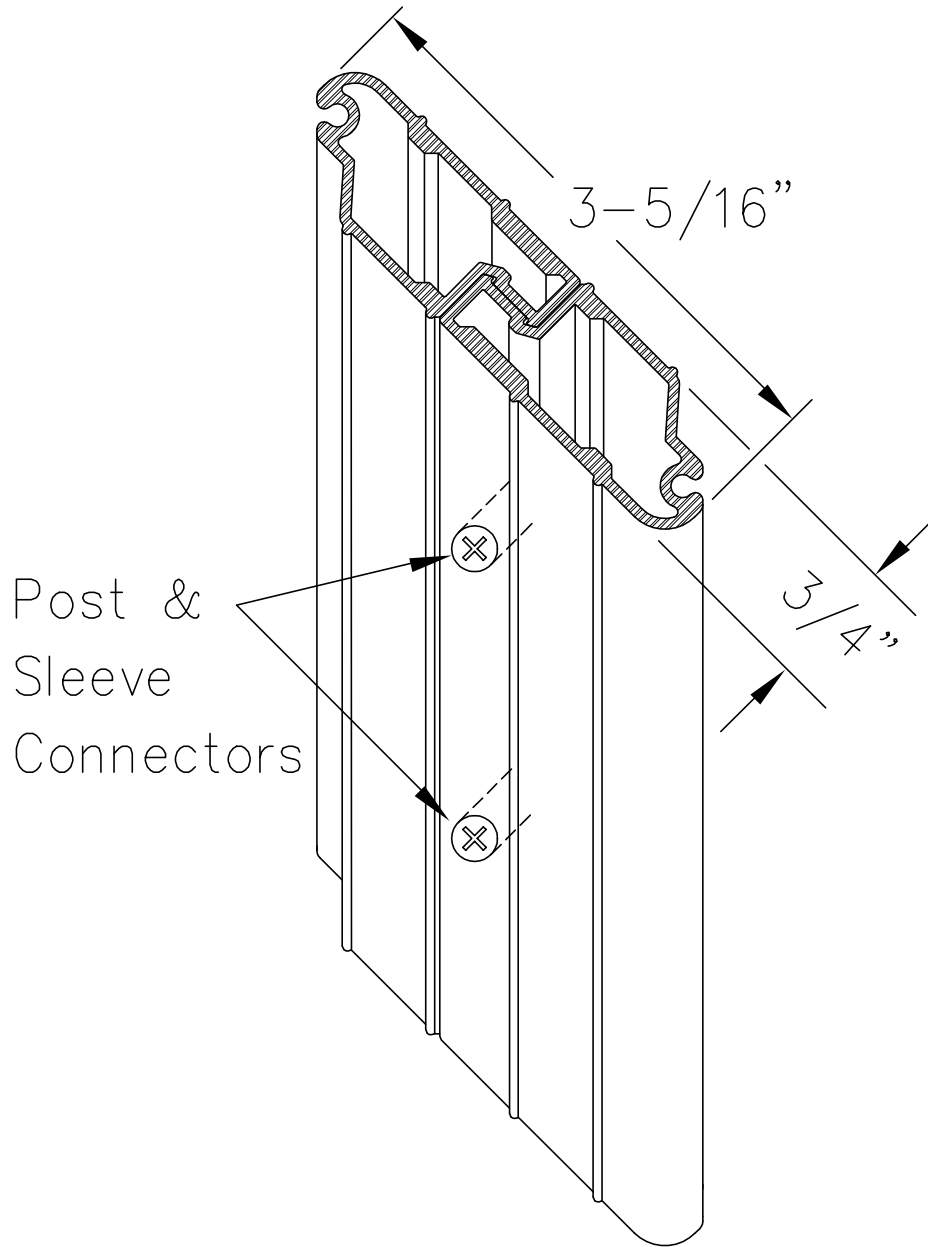

CAD IRP-640

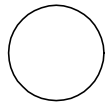

INTERMEDIATE ROLLING POST – MODEL 640