

Intermediate Rolling Post

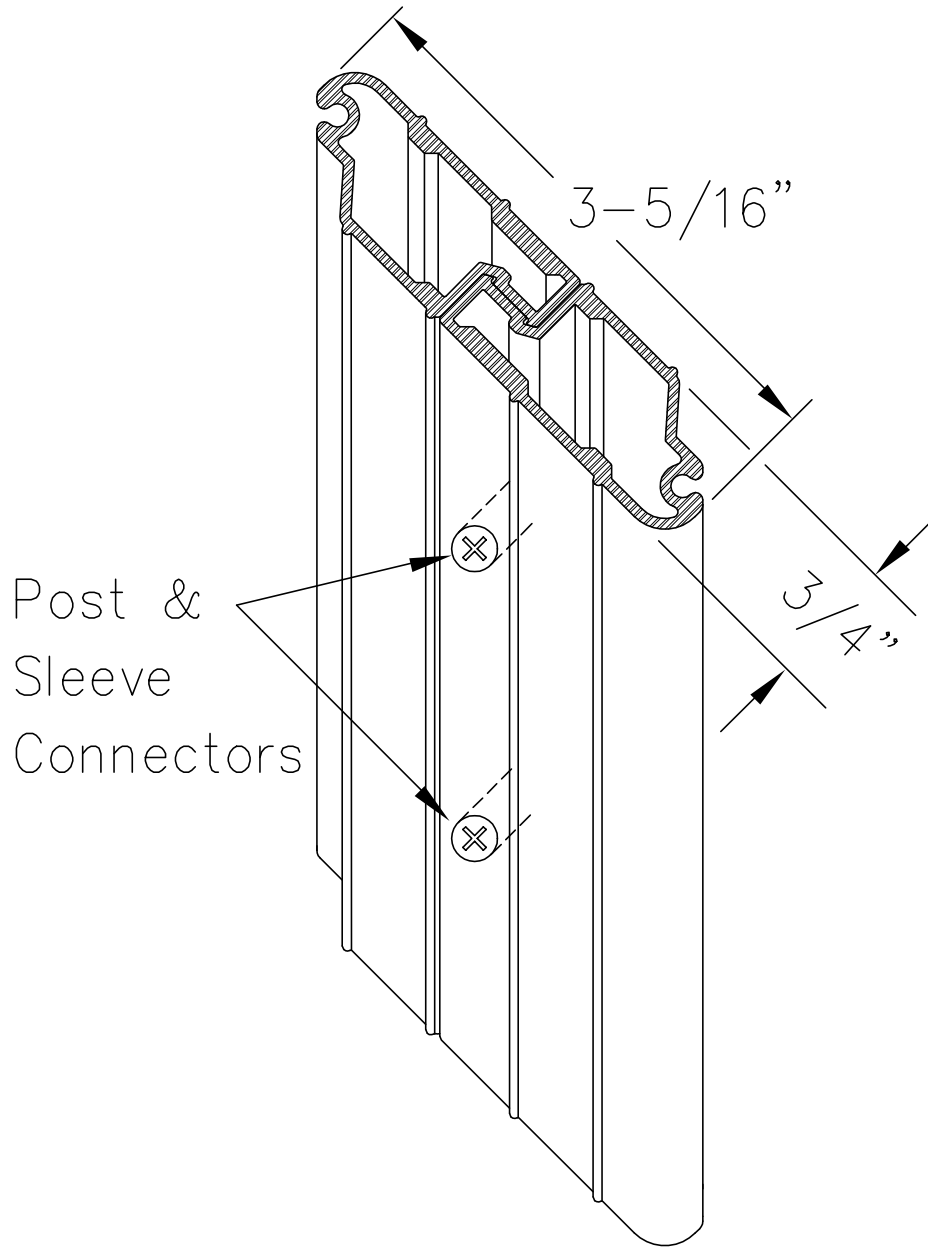

CAD IRP-540

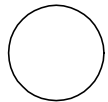

INTERMEDIATE ROLLING POST – MODEL 540