

Surface Track

Pan head screw supplied by manufacturer or equivalent

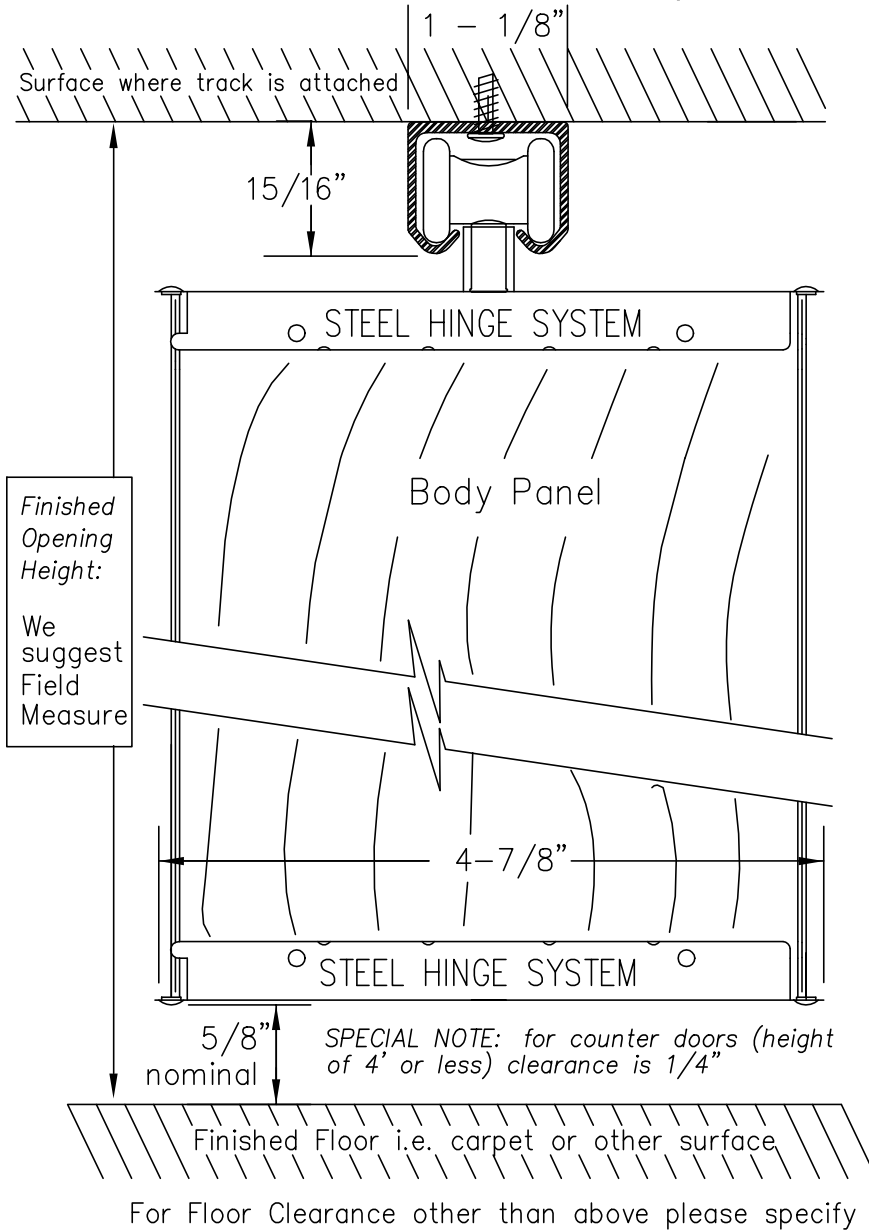

CAD SRTK-220

○ SURFACE TRACK — MODEL 220